



# Dell™ Studio 1735/1737 Service Manual

[Before You Begin](#)  
[Base Cover](#)  
[Hard Drive](#)  
[Memory](#)  
[Coin-Cell Battery](#)  
[Processor Heat Sink](#)  
[Processor](#)  
[Center Control Cover](#)  
[Keyboard](#)  
[Display](#)  
[Camera \(optional\)](#)

[Palm Rest](#)  
[Optical Drive](#)  
[Speakers](#)  
[System Board](#)  
[Fan](#)  
[Charger Board](#)  
[Communication Cards](#)  
[Audio Board](#)  
[Microphone](#)  
[Battery Latch Assembly](#)  
[Flashing the BIOS](#)

---

## Notes, Notices, and Cautions

-  **NOTE:** A NOTE indicates important information that helps you make better use of your computer.
  -  **NOTICE:** A NOTICE indicates either potential damage to hardware or loss of data and tells you how to avoid the problem.
  -  **CAUTION:** A CAUTION indicates a potential for property damage, personal injury, or death.
- 

Information in this document is subject to change without notice.  
© 2008 Dell Inc. All rights reserved.

Reproduction of these materials in any manner whatsoever without the written permission of Dell Inc. is strictly forbidden.

Trademarks used in this text: *Dell* and the *DELL* logo are trademarks of Dell Inc. *Bluetooth* is a registered trademark owned by Bluetooth SIG, Inc. and is used by Dell under license. *Microsoft*, *Windows*, and *Windows Vista* are either trademarks or registered trademarks of Microsoft Corporation in the United States and/or other countries.

Other trademarks and trade names may be used in this document to refer to either the entities claiming the marks and names or their products. Dell Inc. disclaims any proprietary interest in trademarks and trade names other than its own.

Model PP31L

October 2008      Rev. A01

## Audio Board

### Dell™ Studio 1735/1737 Service Manual

- [Removing the Audio Board](#)
- [Replacing the Audio Board](#)

**CAUTION:** Before working inside your computer, read the safety information that shipped with your computer. For additional safety best practices information, see the Regulatory Compliance Homepage at [www.dell.com/regulatory\\_compliance](http://www.dell.com/regulatory_compliance).

**NOTICE:** To avoid electrostatic discharge, ground yourself by using a wrist grounding strap or by periodically touching an unpainted metal surface (such as the back panel) on the computer.

## Removing the Audio Board

1. Follow the instructions in [Before You Begin](#).
2. Press and eject any installed cards from the ExpressCard slot and the 8-in-1 memory card reader.
3. Remove any installed memory modules and Mini-Cards (see [Memory](#) and [Communication Cards](#)).
4. Follow the instructions in [Removing the Palm Rest](#).
5. Remove the screw that secures the audio board and disconnect the audio board cable from the connector on the system board.

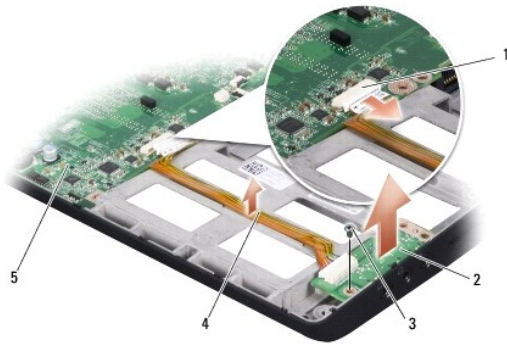

1	audio cable connector	2	audio board
3	screw	4	audio cable
5	system board		

6. Lift the audio board and the cable out of the computer base.

## Replacing the Audio Board

1. Place the audio board in the computer base and replace the screw that secures it.
2. Connect the audio board cable to the connector on the system board.
3. Follow the instructions in [Replacing the Palm Rest](#).
4. Reinstall the memory modules and Mini-Cards, if any.
5. Reinstall any removed cards in the ExpressCard and 8-in-1 card slots.

**NOTICE:** Before turning on the computer, replace all screws and ensure that no stray screws remain inside the computer. Failure to do so may result in damage to the computer.

[Back to Contents Page](#)

## Base Cover

### Dell™ Studio 1735/1737 Service Manual

- [Removing the Base Cover](#)
- [Replacing the Base Cover](#)

**⚠ CAUTION:** Before working inside your computer, follow the safety instructions that shipped with your computer.

**⚠ CAUTION:** Before performing this procedures, turn off the computer, disconnect the AC adapter from the electrical outlet and the computer, disconnect the modem from the wall connector and the computer, and remove any other external cables from the computer.

**🔄 NOTICE:** To avoid electrostatic discharge, ground yourself by using a wrist grounding strap or by periodically touching an unpainted metal surface (such as a connector on the back of the computer).

---

## Removing the Base Cover

1. Ensure that the computer is turned off.
2. Remove the battery (see [Before Working Inside Your Computer](#)).
3. Loosen the eight captive screws on the base cover and lift the cover off the computer at an angle as shown in the figure.

**⚠ CAUTION:** Do not touch the processor heat sink. Processor components should be removed only by trained support personnel.



1	base cover	2	captive screw (8)
---	------------	---	-------------------

---

## Replacing the Base Cover

1. Align the tabs on the base cover to the bottom of the computer.
  2. Replace and tighten the eight captive screws on the base cover.
  3. Slide the battery into the battery bay until it clicks into place.
-

## Battery Latch Assembly

Dell™ Studio 1735/1737 Service Manual

- [Removing the Battery Latch Assembly](#)
- [Replacing the Battery Latch Assembly](#)

**⚠ CAUTION:** Before you begin the following procedure, follow the safety instructions that shipped with your computer.

**🔌 NOTICE:** To avoid electrostatic discharge, ground yourself by using a wrist grounding strap or by periodically touching an unpainted metal surface (such as the back panel) on the computer.

**🔌 NOTICE:** To help prevent damage to the system board, remove the main battery (see [Before Working Inside Your Computer](#)) before working inside the computer.

---

### Removing the Battery Latch Assembly

1. Follow the instructions in [Before Working Inside Your Computer](#).
2. Remove the center control cover (see [Removing the Center Control Cover](#)).
3. Remove the keyboard (see [Removing the Keyboard](#)).
4. Remove the display assembly (see [Display Assembly](#)).
5. Remove the hard drive (see [Removing the Hard Drive](#)).
6. Remove the palm rest (see [Removing the Palm Rest](#)).
7. Remove the system board (see [Removing the System Board](#)).
8. Remove the charger board (see [Removing the Charger Board](#)).
9. Remove the three screws that secure the battery latch assembly to the computer base.
10. Remove the spring from the hook that holds it in place.

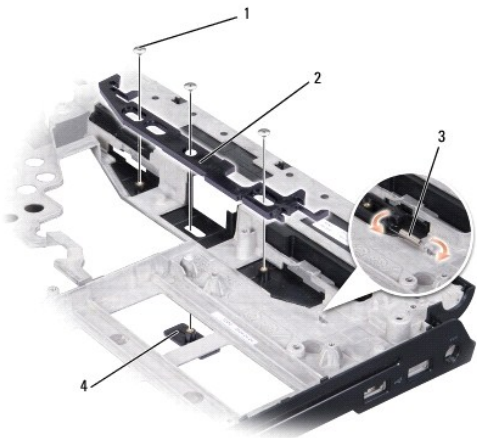

1	screw (3)	2	battery latch assembly
3	spring	4	battery release latch

11. Lift the assembly out of the computer base.
- 

### Replacing the Battery Latch Assembly

1. Place the latch assembly in the channel on the computer base.
2. Using a small screwdriver, place the spring over the hook on the computer base.
3. Replace the three screws.

Ensure that the newly installed latch moves smoothly and freely when pushed and released.

4. Replace the charger board (see [Replacing the Charger Board](#)).
5. Replace the system board (see [Replacing the System Board](#)).
6. Replace the palm rest (see [Replacing the Palm Rest](#)).
7. Replace the hard drive (see [Replacing the Hard Drive](#)).
8. Replace the display assembly (see [Replacing the Display Assembly](#)).
9. Replace the base cover (see [Replacing the Base Cover](#)).
10. Replace the keyboard (see [Replacing the Keyboard](#)).
11. Replace the center control cover (see [Replacing the Center Control Cover](#)).

 **NOTICE:** Before turning on the computer, replace all screws and ensure that no stray screws remain inside the computer. Failure to do so may result in damage to the computer.

12. Slide the battery into the bay until it clicks into place.

---

[Back to Contents Page](#)

[Back to Contents Page](#)

## Before You Begin

### Dell™ Studio 1735/1737 Service Manual

- [Recommended Tools](#)
- [Turning Off Your Computer](#)
- [Before Working Inside Your Computer](#)

This section provides procedures for removing and installing the components in your computer. Unless otherwise noted, each procedure assumes that the following conditions exist:

- 1 You have performed the steps in [Turning Off Your Computer](#) and [Before Working Inside Your Computer](#).
- 1 You have read the safety information that shipped with your computer.
- 1 A component can be replaced or—if purchased separately—installed by performing the removal procedure in reverse order.

---

## Recommended Tools



The procedures in this document may require the following tools:

- 1 Small flat-blade screwdriver
- 1 Phillips screwdriver
- 1 Hex nut driver
- 1 Flash BIOS update program CD

---

## Turning Off Your Computer





 **NOTICE:** To avoid losing data, save and close all open files and exit all open programs before you turn off your computer.

1. Save and close all open files and exit all open programs.
2. In Windows Vista®, click **Start** , click the arrow , and then click **Shut Down**.  
The computer turns off after the operating system shutdown process finishes.
3. Ensure that the computer and any attached devices are turned off. If your computer and attached devices did not automatically turn off when you shut down your operating system, press and hold the power button for at least 8 to 10 seconds until the computer turns off.

---

## Before Working Inside Your Computer

Use the following safety guidelines to help protect your computer from potential damage and to help to ensure your own personal safety.

-  **CAUTION:** Before working inside your computer, read the safety information that shipped with your computer. For additional safety best practices information, see the Regulatory Compliance Homepage at [www.dell.com/regulatory\\_compliance](http://www.dell.com/regulatory_compliance).
-  **NOTICE:** Handle components and cards with care. Do not touch the components or contacts on a card. Hold a card by its edges or by its metal mounting bracket. Hold a component such as a processor by its edges, not by its pins.
-  **NOTICE:** Only a certified service technician should perform repairs on your computer. Damage due to servicing that is not authorized by Dell is not covered by your warranty.
-  **NOTICE:** When you disconnect a cable, pull on its connector or on its pull-tab, not on the cable itself. Some cables have connectors with locking tabs; if you are disconnecting this type of cable, press in on the locking tabs before you disconnect the cable. As you pull connectors apart, keep them evenly aligned to avoid bending any connector pins. Also, before you connect a cable, ensure that both connectors are correctly oriented and aligned.
-  **NOTICE:** To avoid damaging the computer, perform the following steps before you begin working inside the computer.
  1. Ensure that the work surface is flat and clean to prevent the computer cover from being scratched.
  2. Turn off your computer (see [Turning Off Your Computer](#)).

3. If the computer is connected to a docking device (docked), undock it. See the documentation that came with your docking device for instructions.

🔍 **NOTICE:** To disconnect a network cable, first unplug the cable from your computer and then unplug the cable from the network device.

4. Disconnect all telephone or network cables from the computer.

5. Press and eject any installed cards from the ExpressCard slot and the 8-in--1 memory card reader.

6. Disconnect your computer and all attached devices from their electrical outlets.

🔍 **NOTICE:** To help prevent damage to the system board, you must remove the battery from the battery bay before you service the computer.

🔍 **NOTICE:** To avoid damage to the computer, use only the battery designed for this particular Dell computer. Do not use batteries designed for other Dell computers.

7. Turn the computer over.

8. Slide and click the battery latch release.

9. Slide the battery out of the battery bay.

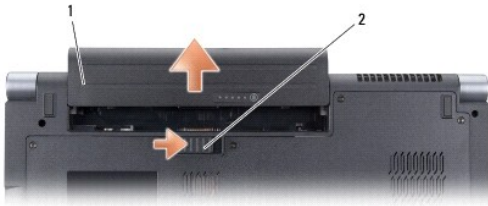

1	battery	2	battery latch release
---	---------	---	-----------------------

10. Press the power button to ground the system board.

---

[Back to Contents Page](#)



## Flashing the BIOS

### Dell™ Studio 1735/1737 Service Manual

- [Flashing the BIOS From a CD](#)
- [Flashing the BIOS From the Hard Drive](#)

If a BIOS-update program CD is provided with the new system board, flash the BIOS from the CD. If you do not have a BIOS-update program CD, flash the BIOS from the hard drive.

---

### Flashing the BIOS From a CD

1. Ensure that the AC adapter is plugged in and that the main battery is installed properly.

 **NOTE:** If you use a BIOS-update program CD to flash the BIOS, set up the computer to boot from a CD before inserting the CD.

2. Insert the BIOS-update program CD, and restart the computer.

Follow the instructions that appear on the screen. The computer continues to boot and updates the new BIOS. When the flash update is complete, the computer will automatically reboot.

3. Press <F2> during POST to enter the system setup program.
  4. Press <Alt> and <F> to reset the computer defaults.
  5. Press <Esc>, select **Save changes and reboot**, and press <Enter> to save configuration changes.
  6. Remove the flash BIOS-update program CD from the drive and restart the computer.
- 

### Flashing the BIOS From the Hard Drive

1. Ensure that the AC adapter is plugged in, the main battery is properly installed, and a network cable is attached.
  2. Turn on the computer.
  3. Locate the latest BIOS update file for your computer at [support.dell.com](http://support.dell.com).
  4. Click **Download Now** to download the file.
  5. If the **Export Compliance Disclaimer** window appears, click **Yes, I Accept this Agreement**.  
The **File Download** window appears.
  6. Click **Save this program to disk** and then click **OK**.  
The **Save In** window appears.
  7. Click the down arrow to view the **Save In** menu, select **Desktop**, and then click **Save**.  
The file downloads to your desktop.
  8. Click **Close** if the **Download Complete** window appears.  
The file icon appears on your desktop and is titled the same as the downloaded BIOS update file.
  9. Double-click the file icon on the desktop and follow the instructions on the screen.
-

## Camera (optional)

### Dell™ Studio 1735/1737 Service Manual

- [Removing the Camera](#)
- [Replacing the Camera](#)

**⚠ CAUTION:** Before working inside your computer, follow the safety instructions that shipped with your computer.

**🔌 NOTICE:** To avoid electrostatic discharge, ground yourself by using a wrist grounding strap or by periodically touching an unpainted metal surface (such as a connector on the back of the computer).

---

## Removing the Camera

1. Follow the instructions in [Before You Begin](#).
2. Follow the instructions in [Display Assembly](#).
3. Remove the display bezel (see [Display Bezel](#)).
4. Pull the camera cable pull-tab to disconnect it from the connector on the camera board.
5. Remove the two screws securing the camera board.

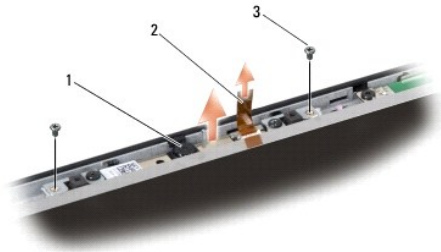

1	camera	2	camera cable pull-tab	3	screw (2)
---	--------	---	-----------------------	---	-----------

6. Remove the camera board.
- 

## Replacing the Camera

1. Align the camera board over the screw holes.
  2. Replace the two screws that secure the camera board to the display.
  3. Connect the camera cable to the connector on the display board.
  4. Replace the display bezel (see [Replacing the Display Bezel](#)).
  5. Follow the instructions in [Replacing the Display Assembly](#).
-

## Center Control Cover

### Dell™ Studio 1735/1737 Service Manual

- [Removing the Center Control Cover](#)
- [Replacing the Center Control Cover](#)

- ⚠ CAUTION:** Before working inside your computer, read the safety information that shipped with your computer. For additional safety best practices information, see the Regulatory Compliance Homepage at [www.dell.com/regulatory\\_compliance](http://www.dell.com/regulatory_compliance).
- ➡ **NOTICE:** To avoid electrostatic discharge, ground yourself by using a wrist grounding strap or by periodically touching an unpainted metal surface (such as a connector on the back of the computer).
- ➡ **NOTICE:** To help prevent damage to the system board, you must remove the battery from the battery bay before you begin working inside the computer.
- 

## Removing the Center Control Cover

1. Follow the procedures in [Before You Begin](#).
2. Turn the computer over and remove the screw that secures the center control cover to the computer base.



3. Turn the computer top side up, and open the display as far as it will open.
4. Ease the center control cover up with a plastic scribe from the back of the computer.
5. Ease the center control cover up until you see the media control buttons cable that attaches the center control cover to the system board.

- ➡ **NOTICE:** Be extremely careful when removing the center control cover. The cover along with the cable that attaches it to the system board are very fragile.

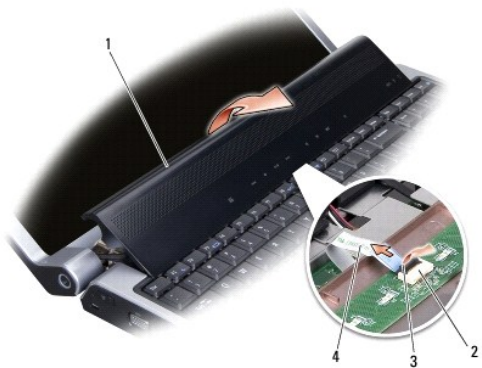

1	center control cover	2	media control buttons cable	3	connector latch
4	media control buttons cable				

6. Release the connector latch that secures the cable to the connector on the center control cover and remove the cable.
7. Lift the center control cover off the computer.

---

## Replacing the Center Control Cover

1. Slide the media control buttons cable into the connector on the center control cover until it is in position and pull down on the connector latch that secures the cable to the connector.
2. Align the hooks beneath the center control cover and snap the cover in place.
3. Turn the computer over and replace the screw that secures the center control cover to the computer base.
4. Slide the battery into the bay until it clicks into place.

---

[Back to Contents Page](#)

## Charger Board

### Dell™ Studio 1735/1737 Service Manual

- [Removing the Charger Board](#)
- [Replacing the Charger Board](#)

- ⚠ CAUTION:** Before working inside your computer, read the safety information that shipped with your computer. For additional safety best practices information, see the Regulatory Compliance Homepage at [www.dell.com/regulatory\\_compliance](http://www.dell.com/regulatory_compliance).
- ➡ NOTICE:** To avoid electrostatic discharge, ground yourself by using a wrist grounding strap or by periodically touching an unpainted metal surface (such as a connector on the back of the computer).
- ➡ NOTICE:** To help prevent damage to the system board, you must remove the battery from the battery bay before you begin working inside the computer.
- 

## Removing the Charger Board

1. Follow the procedures in [Before You Begin](#).
2. Press and eject any installed cards from the ExpressCard slot and the 8-in-1 memory card reader.
3. Remove any installed memory modules and Mini-Cards (see [Memory](#) and [Communication Cards](#)).
4. Follow the instructions in [Removing the System Board](#).
5. Remove the two screws that secure the charger board to the computer base.

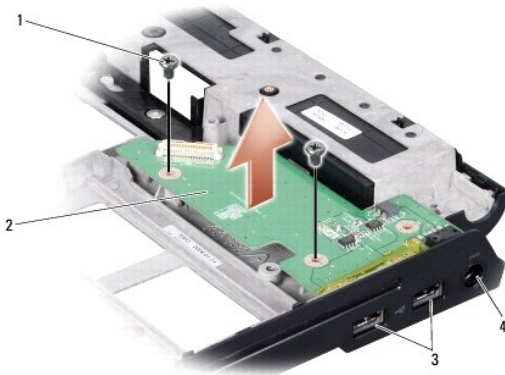

1	screw (2)	2	charger board
3	USB connector (2)	4	AC adapter connector

6. Lift the charger board out of the computer base.
- 

## Replacing the Charger Board

1. Place the charger board in the computer base.
  2. Replace the two screws that secure the charger board to the computer base.
  3. Follow the instructions in [Replacing the System Board](#).
-

## Coin-Cell Battery

### Dell™ Studio 1735/1737 Service Manual

- [Removing the Coin-Cell Battery](#)
- [Replacing the Coin-Cell Battery](#)

- ⚠ CAUTION:** Before working inside your computer, read the safety information that shipped with your computer. For additional safety best practices information, see the Regulatory Compliance Homepage at [www.dell.com/regulatory\\_compliance](http://www.dell.com/regulatory_compliance).
- ➡ NOTICE:** To avoid electrostatic discharge, ground yourself by using a wrist grounding strap or by periodically touching an unpainted metal surface (such as a connector on the back of the computer).
- ➡ NOTICE:** To help prevent damage to the system board, you must remove the battery from the battery bay before you begin working inside the computer.
- 

## Removing the Coin-Cell Battery

1. Follow the procedures in [Before You Begin](#).
2. Turn the computer over and remove the base cover (see [Removing the Base Cover](#)).



1	coin-cell battery
---	-------------------

3. Use a plastic scribe to push the coin cell battery forward and upward to release it from the slot.
- 

## Replacing the Coin-Cell Battery

1. Replace the coin cell battery with the positive (+) side facing upwards.
  2. Replace the base cover (see [Replacing the Base Cover](#)).
  3. Slide the battery into the bay until it clicks into place.
-

## Processor

### Dell™ Studio 1735/1737 Service Manual

- [Removing the Processor](#)
- [Installing the Processor](#)

**⚠ CAUTION:** Before working inside your computer, follow the safety instructions that shipped with your computer.

**🔄 NOTICE:** To avoid electrostatic discharge, ground yourself by using a wrist grounding strap or by periodically touching an unpainted metal surface (such as a connector on the back of the computer).

**🔄 NOTICE:** To prevent intermittent contact between the ZIF-socket cam screw and the processor when removing or replacing the processor, press to apply slight pressure to the center of the processor while turning the cam screw.

**🔄 NOTICE:** To avoid damage to the processor, hold the screwdriver such that it is perpendicular to the processor when turning the cam screw.

---

## Removing the Processor

1. Follow the instructions in [Before You Begin](#).
2. Turn the computer over and remove the base cover (see [Removing the Base Cover](#)).
3. Remove the processor heat sink (see [Removing the Processor Heat Sink](#)).

**🔄 NOTICE:** When removing the processor, pull it straight up. Be careful not to bend the pins on the processor.

**🔄 NOTICE:** To prevent intermittent contact between the ZIF-socket cam screw and the processor when removing or replacing the processor, press to apply slight pressure to the center of the processor while turning the cam screw.

4. To loosen the ZIF socket, use a small, flat-blade screwdriver and rotate the ZIF-socket cam screw counterclockwise until it comes to the cam stop.

The ZIF-socket cam screw secures the processor to the system board. Take note of the arrow on the ZIF-socket cam screw.

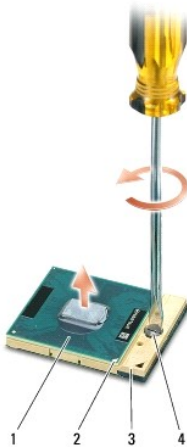

1	processor	2	pin-1 corner of processor	3	ZIF socket
4	ZIF-socket cam screw				

5. Use a processor extraction tool to remove the processor.

---

## Installing the Processor

➡ **NOTICE:** Ensure that the cam lock is in the fully open position before seating the processor. Seating the processor properly in the ZIF socket does not require force.

➡ **NOTICE:** A processor that is not properly seated can result in an intermittent connection or permanent damage to the processor and ZIF socket.

1. Align the pin-1 corner of the processor so that it points to the triangle on the ZIF socket, and insert the processor into the ZIF socket.

When the processor is correctly seated, all four corners are aligned at the same height. If one or more corners of the processor are higher than the others, the processor is not seated correctly.

➡ **NOTICE:** To prevent intermittent contact between the ZIF-socket cam screw and the processor when removing or replacing the processor, press to apply slight pressure to the center of the processor while turning the cam screw.

2. Tighten the ZIF socket by turning the cam screw clockwise to secure the processor to the system board.
3. Peel the backing off the thermal cooling pad and adhere the pad to the portion of the processor heat sink that covers the processor.
4. Replace the processor heat sink (see [Replacing the Processor Heat Sink](#)).
5. Replace the base cover (see [Replacing the Base Cover](#)).
6. Slide the battery into the bay until it clicks into place.
7. Update the BIOS using a flash BIOS-update program CD. See ([Flashing the BIOS](#)).

---

[Back to Contents Page](#)



## Processor Heat Sink

Dell™ Studio 1735/1737 Service Manual

- [Removing the Processor Heat Sink](#)
- [Replacing the Processor Heat Sink](#)

**CAUTION:** Before working inside your computer, follow the safety instructions that shipped with your computer.

**NOTICE:** To avoid electrostatic discharge, ground yourself by using a wrist grounding strap or by periodically touching an unpainted metal surface (such as a connector on the back of the computer).

### Removing the Processor Heat Sink

1. Follow the instructions in [Before You Begin](#).
2. Turn the computer over and remove the base cover (see [Removing the Base Cover](#)).
3. Loosen the three captive screws that secure the processor heat sink to the system board.

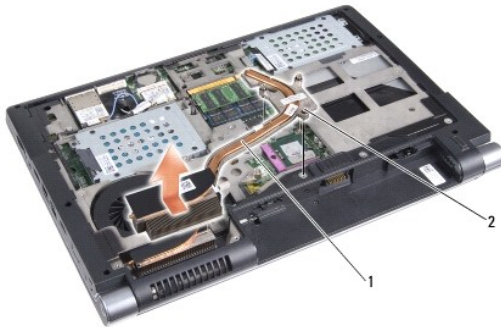

1	processor heat sink	2	captive screw (3)
---	---------------------	---	-------------------

4. Lift the processor heat sink off the computer.

### Replacing the Processor Heat Sink

**CAUTION:** Before working inside your computer, follow the safety instructions that shipped with your computer.

**NOTICE:** To prevent static damage to components inside your computer, discharge static electricity from your body before you touch any of your computer's electronic components. You can do so by touching an unpainted metal surface.

**NOTE:** The original pad can be reused if the original processor and heat sink are reinstalled together. If either the processor or heat sink is replaced, use the thermal pad provided in the kit to ensure that thermal conductivity is achieved.

**NOTE:** This procedure assumes that you have already removed the processor heat sink and are ready to replace it.

1. Peel the backing off the thermal cooling pad and adhere the pad to the portion of the heat sink that covers the processor.
2. Place the processor heat sink on the system board.
3. Tighten the three captive screws that secure the processor heat sink to the system board.
4. Replace the base cover (see [Replacing the Base Cover](#)).
5. Slide the battery into the bay until it clicks into place.

[Back to Contents Page](#)

[Back to Contents Page](#)

## Display

### Dell™ Studio 1735/1737 Service Manual

- [Display Assembly](#)
- [Display Bezel](#)
- [Removing the Display Panel](#)
- [Display Panel Cable](#)
- [Display Inverter](#)
- [Display Hinges](#)

**⚠ CAUTION:** Before working inside your computer, read the safety information that shipped with your computer. For additional safety best practices information, see the Regulatory Compliance Homepage at [www.dell.com/regulatory\\_compliance](http://www.dell.com/regulatory_compliance).

**🔌 NOTICE:** To avoid electrostatic discharge, ground yourself by using a wrist grounding strap or by periodically touching an unpainted metal surface (such as a connector on the back of the computer).

**🔌 NOTICE:** To help prevent damage to the system board, you must remove the battery from the battery bay before you begin working inside the computer.

---

## Display Assembly

### Removing the Display Assembly

1. Follow the instructions in [Before You Begin](#).
2. Remove the Center Control Cover (see [Removing the Center Control Cover](#)).
3. Turn the computer over and remove the base cover (see [Removing the Base Cover](#)).
4. Remove the Mini-Card cables from the Mini-Cards, if applicable (see [Wireless Mini-Cards](#)).
5. Make note of the cable routing and carefully dislodge the Mini-Card antenna cables from their routing guides.

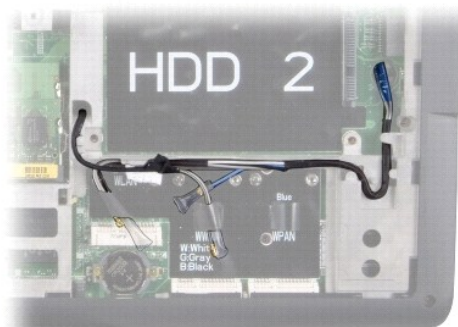

6. Turn the computer over.
7. Remove the keyboard (see [Removing the Keyboard](#)).
8. Make note of the cable routing and carefully dislodge the Mini-Card antenna cables from their routing guides and pull the cables out through the system board so that they are clear of the computer base.
9. Pull the display cable pull-tab to disconnect the display cable from the display connector on the system board.
10. Disconnect the optional camera cable and Wi-Fi Sniffer/Power Button Board cable connector from the system board.

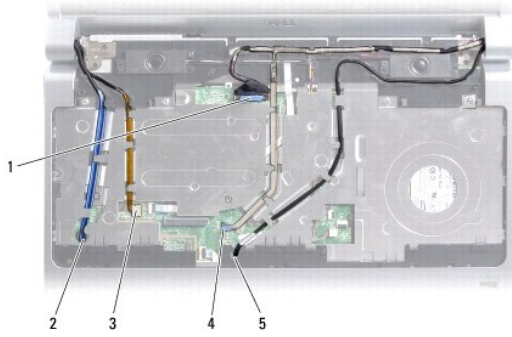

1	display cable pull-tab	2	WPAN/WWAN cable routing slot
3	Wi-Fi Sniffer/Power Button Board cable connector	4	camera cable pull-tab (optional)
5	WLAN cable routing slot		

11. Make note of the cable routing and carefully dislodge the cables from their routing guides.

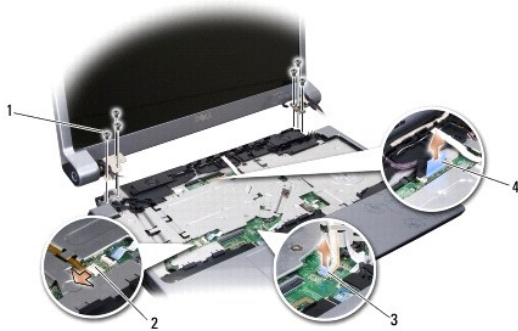

1	screw (3 on each side; total 6)	2	Wi-Fi Sniffer/Power Button Board cable connector
3	camera cable pull-tab (optional)	4	display cable pull-tab

12. Remove the three screws from each side of the display assembly.

13. Remove the display assembly.

## Replacing the Display Assembly

1. Place the display assembly in position and replace the three screws on each side.
2. Route the optional camera cable, Wi-Fi Sniffer/Power Button Board cable, and display cable through the routing guides and connect the cable connectors to the system board.
3. Make note of the cable routing and carefully slide the Mini-Card antenna cables through the system board and into their routing guides.
4. Replace the keyboard (see [Replacing the Keyboard](#)).
5. Replace the center control cover (see [Replacing the Center Control Cover](#)).
6. Turn the computer over.
7. Make note of the cable routing and carefully insert the Mini-Card antenna cables through their routing guides.
8. Reconnect the Mini-Card cables to the Mini-Cards, if applicable (see [Wireless Mini-Cards](#)).
9. Replace the base cover (see [Replacing the Base Cover](#)).

➡ **NOTICE:** Before turning on the computer, replace all screws and ensure that no stray screws remain inside the computer. Failure to do so may result in damage to the computer.

10. Slide the battery into the bay until it clicks into place.

---

## Display Bezel

### Removing the Display Bezel

➡ **NOTICE:** The display bezel is extremely fragile. Be careful when removing it to prevent damaging the bezel.

1. Follow the instructions in [Display Assembly](#).
2. Using your fingertips, carefully pry up the inside edge of the display bezel.
3. Remove the display bezel.



1	display bezel		
---	---------------	--	--

### Replacing the Display Bezel

1. Realign the display bezel over the display panel, and gently snap into place.
  2. Follow the instructions in [Replacing the Display Assembly](#).
- 

## Removing the Display Panel

### Removing the Display Panel

1. Follow the instructions in [Display Assembly](#).
2. Remove the display bezel (see [Display Bezel](#)).
3. Remove the six screws securing the display panel.

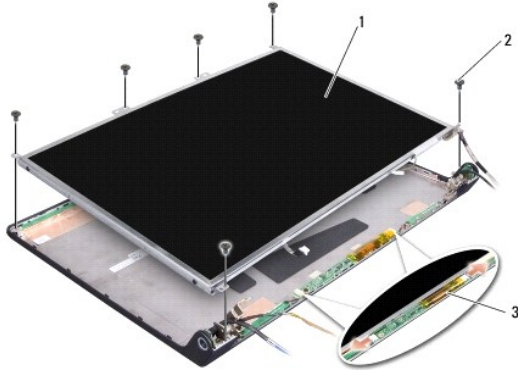

1	display panel	2	screw (6)
3	inverter board		

4. Disconnect the cables from the connectors on either side of the inverter board.
5. Remove the display panel.
6. Remove the four screws (two on each side) that secure the display panel brackets to the display panel.

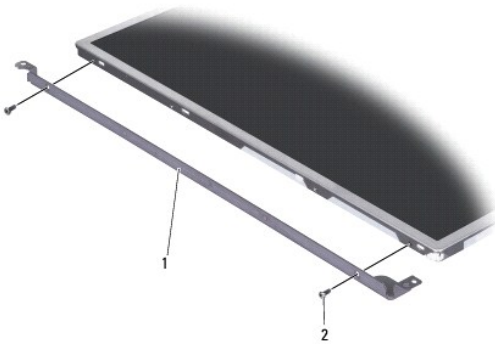

1	display panel bracket (1 left, 1 right)	2	screw (4 total; 2 on each side)
---	---	---	---------------------------------

## Replacing the Display Panel

1. Attach the display bracket to the display panel by replacing the two screws on each side of the display panel.
2. Align the display panel with the display back and connect the cables to the connectors on either side of the inverter board.
3. Replace the six screws to secure the display panel to the display cover.
4. Replace the display bezel (see [Replacing the Display Bezel](#)).
5. Follow the instructions in [Replacing the Display Assembly](#).

## Display Panel Cable

### Removing the Display Panel Cable

**NOTE:** The Display Panel cables and connectors may differ depending on the Display Panel you ordered.

1. Follow the instructions in [Display Assembly](#).

2. Remove the display bezel (see [Display Bezel](#)).
3. Remove the display panel (see [Removing the Display Panel](#)).
4. Turn the display panel over and place it on a clean surface.

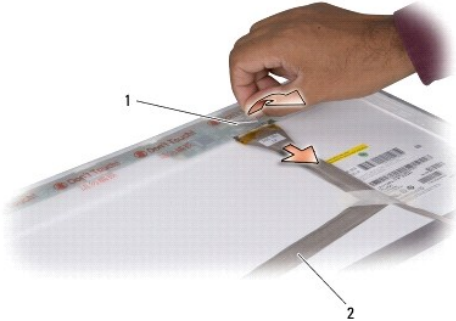

1	tape	2	display cable
---	------	---	---------------

5. Lift the tape that secures the display cable to the connector on top and disconnect the cable from the connector.

## Replacing the Display Panel Cable

1. Reconnect the display cable to the connector on top and secure it with the tape.
2. Replace the display panel (see [Replacing the Display Panel](#)).
3. Replace the display bezel (see [Replacing the Display Bezel](#)).
4. Follow the instructions in [Replacing the Display Assembly](#).

## Display Inverter

### Removing the Display Inverter

1. Follow the instructions in [Display Assembly](#).
2. Remove the display bezel (see [Display Bezel](#)).
3. Disconnect the cables from the connectors on either side of the inverter board.

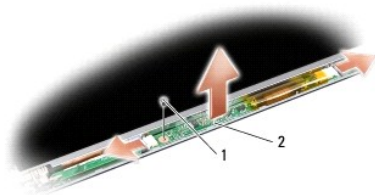

1	screw	2	inverter board
---	-------	---	----------------

4. Remove the screw that secures the inverter board and lift the inverter board off the display assembly.

### Replacing the Display Inverter

1. Replace the screw that secures the inverter board.
  2. Connect the cables to the connectors on either side of the inverter board.
  3. Replace the display bezel (see [Replacing the Display Bezel](#)).
  4. Follow the instructions in [Replacing the Display Assembly](#).
- 

## Display Hinges

### Removing the Display Hinges

1. Follow the instructions in [Display Assembly](#).
2. Remove the display bezel (see [Display Bezel](#)).
3. Remove the display panel (see [Removing the Display Panel](#)).
4. Remove the four screws (two on each side) that secure the hinges to the display cover and remove the hinges.

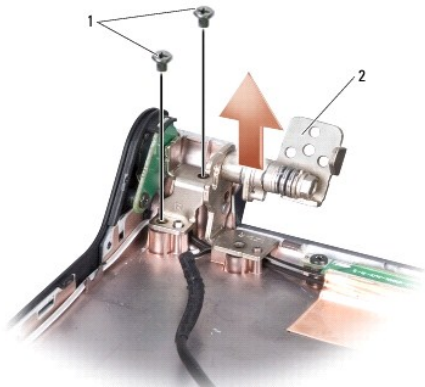

1	screw (4 total; 2 on each side)	2	hinge (1 left, 1 right)
---	---------------------------------	---	-------------------------

### Replacing the Display Hinges

1. Replace the hinges and replace the four screws (two on each side) that secure the hinges to the display cover.
  2. Replace the display panel (see [Replacing the Display Panel](#)).
  3. Replace the display bezel (see [Replacing the Display Bezel](#)).
  4. Follow the instructions in [Replacing the Display Assembly](#).
- 

[Back to Contents Page](#)



## Fan

### Dell™ Studio 1735/1737 Service Manual

- [Removing the Fan](#)
- [Replacing the Fan](#)

**⚠ CAUTION:** Before working inside your computer, follow the safety instructions that shipped with your computer.

**🔌 NOTICE:** To avoid electrostatic discharge, ground yourself by using a wrist grounding strap or by periodically touching an unpainted metal surface (such as a connector on the back of the computer).

---

## Removing the Fan

1. Follow the instructions in [Before You Begin](#).
2. Follow the instructions in [Removing the System Board](#).
3. Remove the screw that secures the fan to the computer base.

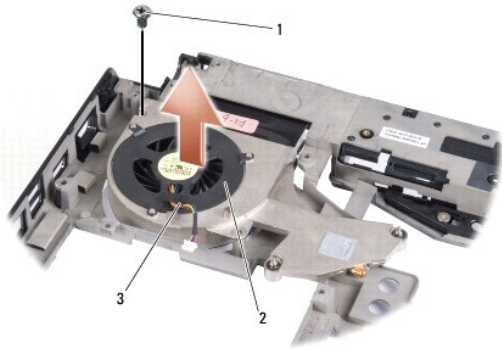

1	screw	2	fan
3	fan cable		

4. Lift the fan, along with the cable, off the computer.
- 

## Replacing the Fan

**⚠ CAUTION:** Before working inside your computer, follow the safety instructions that shipped with your computer.

**🔌 NOTICE:** To prevent static damage to components inside your computer, discharge static electricity from your body before you touch any of your computer's electronic components. You can do so by touching an unpainted metal surface.

**🔧 NOTE:** This procedure assumes that you have already removed the fan and are ready to replace it.

1. Place the fan, along with the cable, on the computer base.
  2. Replace the screw that secures the fan to the computer base.
  3. Follow the instructions [Replacing the System Board](#).
-

## Hard Drive

### Dell™ Studio 1735/1737 Service Manual

- [Removing the Hard Drive](#)
- [Replacing the Hard Drive](#)

- ⚠ **CAUTION:** If you remove the hard drive from the computer when the drive is hot, *do not touch* the metal housing of the hard drive.
- ⚠ **CAUTION:** Before working inside your computer, read the safety information that shipped with your computer. For additional safety best practices information, see the Regulatory Compliance Homepage at [www.dell.com/regulatory\\_compliance](http://www.dell.com/regulatory_compliance).
- ➡ **NOTICE:** To prevent data loss, turn off your computer (see [Turning Off Your Computer](#)) before removing the hard drive. Do not remove the hard drive while the computer is ON or in Sleep state.
- ➡ **NOTICE:** Hard drives are extremely fragile. Exercise care when handling the hard drive.
- ➡ **NOTICE:** Only a certified service technician should perform repairs on your computer. Damage due to servicing that is not authorized by Dell is not covered by your warranty.
- ➡ **NOTICE:** When you disconnect a cable, pull on its connector or on its pull-tab, not on the cable itself. Some cables have connectors with locking tabs; if you are disconnecting this type of cable, press in on the locking tabs before you disconnect the cable. As you pull connectors apart, keep them evenly aligned to avoid bending any connector pins. Also, before you connect a cable, ensure that both connectors are correctly oriented and aligned.
- 🔧 **NOTE:** Dell does not guarantee compatibility or provide support for hard drives from sources other than Dell.
- 🔧 **NOTE:** If you are installing a hard drive from a source other than Dell, you need to install an operating system, drivers, and utilities on the new hard drive (see the *Dell Technology Guide*).

## Removing the Hard Drive

1. Follow the procedures in [Before You Begin](#).
2. Turn the computer over and remove the base cover (see [Removing the Base Cover](#)).
3. Detach the hard drive from the system board connector.
  - 1 For Hard Drive 1:
    - o Remove the four screws securing the hard drive assembly to the computer base.
    - o Pull the blue pull-tab on the cable attached to the system board to disconnect the cable.
    - o Pull the black pull-tab to lift the hard drive assembly out of the computer.

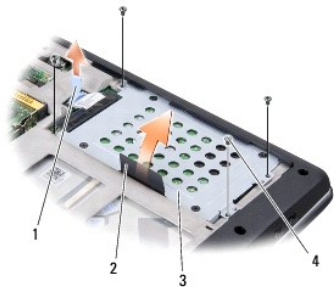

1	blue pull-tab	2	black pull-tab
3	hard drive assembly	4	screws (4)

- o Pull the interposer to disconnect it from the hard drive.

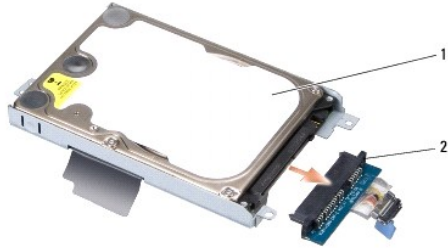

1	hard drive	2	interposer
---	------------	---	------------

- o Remove the four M3 x 3-mm screws securing the hard drive cage to the hard drive.

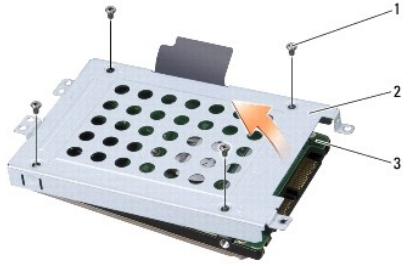

1	M3 x 3-mm screws (4)	2	hard drive cage
3	hard drive		

1 For Hard Drive 2:

- o Remove the four screws securing the hard drive assembly to the computer base.
- o Pull the black pull-tab on the hard drive to disconnect the hard drive from the system board connector and to lift the hard drive assembly out of the computer.

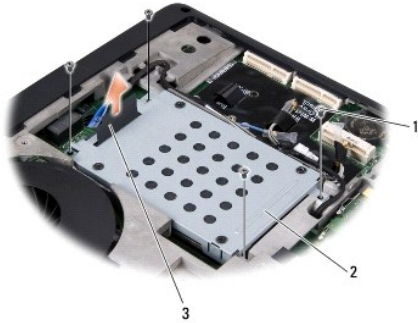

1	screws (4)	2	hard drive assembly
3	black pull-tab		

- o Remove the four M3 x 3-mm screws securing the hard drive cage to the hard drive.

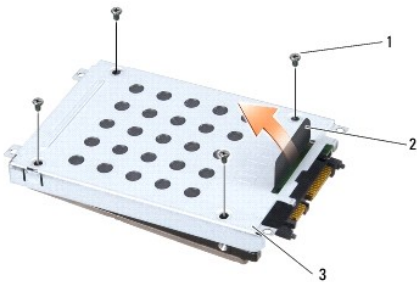

1	M3 x 3-mm screws (4)	2	black pull-tab
3	hard drive cage		

- 
- o Pull the interposer to detach it from the hard drive.



1	hard drive	2	interposer
---	------------	---	------------

4. Lift the hard drive cage off the hard drive.

**NOTICE:** When the hard drive is not in the computer, store it in protective antistatic packaging (see "Protecting Against Electrostatic Discharge" in the safety instructions that shipped with your computer.)

---

## Replacing the Hard Drive

1. Remove the new drive from its packaging.

Save the original packaging for storing or shipping the hard drive.

2. Replace the hard drive in the bay.

- 1 For Hard Drive 1:

- o Replace the four M3 x 3-mm screws securing the hard drive cage to the hard drive.
- o Connect the interposer to the hard drive.
- o Replace the four screws securing the hard drive assembly to the computer base.
- o Connect the cable with the blue pull-tab to the system board connector.

- 1 For Hard Drive 2:

**NOTICE:** Use firm and even pressure to slide the drive into place. If you use excessive force, you may damage the connector.

- o Connect the interposer to the hard drive.
- o Replace the four M3 x 3-mm screws securing the hard drive cage to the hard drive.
- o Press the hard drive firmly on to the system board connector.
- o Replace the four screws securing the hard drive assembly to the computer base.

- 1 Replace the base cover (see [Replacing the Base Cover](#)).

**NOTICE:** Before turning on the computer, replace all screws and ensure that no stray screws remain inside the computer. Failure to do so may result in damage to the computer.

4. Slide the battery into the bay until it clicks into place.
  5. Install the operating system for your computer, as needed (see *Dell Technology Guide*).
  6. Install the drivers and utilities for your computer, as needed (see *Dell Technology Guide*).
- 

[Back to Contents Page](#)

[Back to Contents Page](#)

## Keyboard

### Dell™ Studio 1735/1737 Service Manual

- [Removing the Keyboard](#)
- [Replacing the Keyboard](#)

- ⚠ CAUTION:** Before working inside your computer, read the safety information that shipped with your computer. For additional safety best practices information, see the Regulatory Compliance Homepage at [www.dell.com/regulatory\\_compliance](http://www.dell.com/regulatory_compliance).
- ➡ NOTICE:** To avoid electrostatic discharge, ground yourself by using a wrist grounding strap or by periodically touching an unpainted metal surface (such as a connector on the back of the computer).
- ➡ NOTICE:** To help prevent damage to the system board, you must remove the battery from the battery bay before you begin working inside the computer.
- 

## Removing the Keyboard

1. Follow the procedures in [Before You Begin](#).
2. Remove the Center Control Cover (see [Removing the Center Control Cover](#)).
3. Ease the keyboard surround up with a plastic scribe.



1	keyboard surround
---	-------------------

4. Lift the keyboard surround off the computer.
  5. Remove the four screws at the top of the keyboard.
- ➡ NOTICE:** The keycaps on the keyboard are fragile, easily dislodged, and time-consuming to replace. Be careful when removing and handling the keyboard.
6. Carefully slide the keyboard out of the computer and turn it over as shown in the illustration. Do not pull hard on the keyboard.
- ➡ NOTICE:** Be extremely careful when removing and handling the keyboard. Failure to do so could result in scratching the display panel.



1	screw (4)	2	keyboard
3	keyboard tab (6)	4	connector latch
5	keyboard cable		

7. Release the connector latch that secures the keyboard cable to the connector on the system board and release the cable.
8. Lift the keyboard off the computer.

## Replacing the Keyboard

1. Slide the keyboard cable into the connector on the system board and pull down on the connector latch that secures the keyboard cable to the system board.
2. Align the tabs along the bottom of the keyboard with the slots of the palm rest and slide the keyboard under the palm rest.

**NOTICE:** The keycaps on the keyboard are fragile, easily dislodged, and time-consuming to replace. Be careful when removing and handling the keyboard.

3. Replace the four screws at the top of the keyboard.
4. Align the hooks beneath the keyboard surround and snap it into place.
5. Replace the Center Control Cover (see [Replacing the Center Control Cover](#)).
6. Slide the battery into the bay until it clicks into place.

[Back to Contents Page](#)

[Back to Contents Page](#)

## Memory

### Dell™ Studio 1735/1737 Service Manual

- [Removing the Memory Module\(s\)](#)
- [Replacing the Memory Module\(s\)](#)

**⚠ CAUTION:** Before working inside your computer, read the safety information that shipped with your computer. For additional safety best practices information, see the [Regulatory Compliance Homepage](http://www.dell.com/regulatory_compliance) at [www.dell.com/regulatory\\_compliance](http://www.dell.com/regulatory_compliance).

You can increase your computer memory by installing memory modules on the system board. See "Specifications" in your *Quick Reference Guide* for information on the memory supported by your computer. Install only memory modules that are intended for your computer.

**📌 NOTE:** Memory modules purchased from Dell are covered under your computer warranty.

Your computer has two user-accessible SODIMM sockets that can be accessed from the bottom of the computer. The DIMM B memory module is located directly above the DIMM A memory module located on the bottom of the computer.

**➡ NOTICE:** If you need to install memory modules in two connectors, install a memory module in the connector labeled "DIMM A" before you install a module in the connector labeled "DIMM B."

## Removing the Memory Module(s)

**➡ NOTICE:** To avoid electrostatic discharge, ground yourself by using a wrist grounding strap or by periodically touching an unpainted metal surface (such as a connector on the back of the computer).

1. Follow the procedures in [Before You Begin](#).
2. Turn the computer over and remove the base cover (see [Removing the Base Cover](#)).



1	DIMM B memory module	2	DIMM A memory module
---	----------------------	---	----------------------

**➡ NOTICE:** To prevent damage to the memory module connector, do not use tools to spread the memory module securing clips.

3. Use your fingertips to carefully spread apart the securing clips on each end of the memory module connector until the module pops up.
4. Remove the module from the connector.

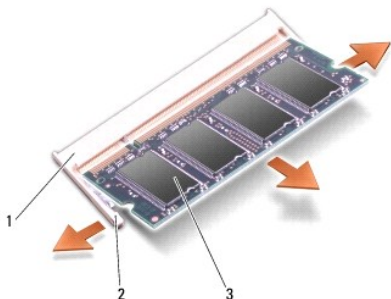

1	memory module connector	2	securing clip (2)
3	memory module		

## Replacing the Memory Module(s)

**NOTICE:** To avoid electrostatic discharge, ground yourself by using a wrist grounding strap or by periodically touching an unpainted metal surface (such as a connector on the back of the computer).

1. Align the notch in the module edge connector with the tab in the connector slot.
2. Slide the module firmly into the slot at a 45-degree angle, and press the module down until it clicks into place. If you do not feel the click, remove the module and reinstall it.

**NOTE:** If the memory module is not installed properly, the computer may not boot.

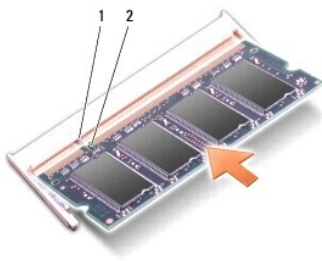

1	tab	2	notch
---	-----	---	-------

**NOTICE:** If the cover is difficult to close, remove the module and reinstall it. Forcing the cover to close may damage your computer.

3. Replace the base cover (see [Replacing the Base Cover](#)).
4. Slide the battery into the battery bay, or connect the AC adapter to your computer and an electrical outlet.
5. Turn on the computer.

As the computer boots, it detects the additional memory and automatically updates the system configuration information.

To confirm the amount of memory installed in the computer, click **Start** → **Help and Support** → **Dell System Information**.

[Back to Contents Page](#)



## Microphone

### Dell™ Studio 1735/1737 Service Manual

- [Removing the Microphone](#)
- [Replacing the Microphone](#)

**⚠ CAUTION:** Before working inside your computer, read the safety information that shipped with your computer. For additional safety best practices information, see the Regulatory Compliance Homepage at [www.dell.com/regulatory\\_compliance](http://www.dell.com/regulatory_compliance).

**🔧 NOTICE:** To avoid electrostatic discharge, ground yourself by using a wrist grounding strap or by periodically touching an unpainted metal surface (such as the back panel) on the computer.

---

## Removing the Microphone

1. Follow the instructions in [Before You Begin](#).
2. Press and eject any installed cards from the ExpressCard slot and the 8-in-1 memory card reader.
3. Remove any installed memory modules and Mini-Cards (see [Memory](#) and [Communication Cards](#)).
4. Follow the instructions in [Removing the Palm Rest](#).
5. Disconnect the microphone cable connector.
6. Remove the microphone from the computer base.

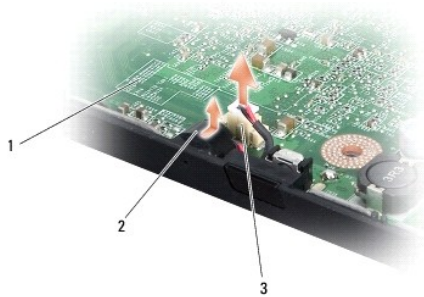

1	system board	2	microphone
3	microphone cable connector		

---

## Replacing the Microphone

1. Place the microphone in the computer base.
2. Connect the microphone cable to the connector on the system board.
3. Follow the instructions in [Replacing the Palm Rest](#).
4. Reinstall the memory modules and Mini-Cards, if any.
5. Reinstall any removed cards in the ExpressCard and 8-in-1 card slots.

**🔧 NOTICE:** Before turning on the computer, replace all screws and ensure that no stray screws remain inside the computer. Failure to do so may result in damage to the computer.



## Communication Cards

### Dell™ Studio 1735/1737 Service Manual

- [Subscriber Identity Module](#)
- [Wireless Mini-Cards](#)

---

## Subscriber Identity Module

Subscriber Identity Modules (SIM) identify users uniquely through an International Mobile Subscriber Identity.

### Installing the SIM

**CAUTION:** Before working inside your computer, read the safety information that shipped with your computer. For additional safety best practices information, see the [Regulatory Compliance Homepage](http://www.dell.com/regulatory_compliance) at [www.dell.com/regulatory\\_compliance](http://www.dell.com/regulatory_compliance).

**NOTE:** Only GSM (HSDPA) type cards need a SIM. EVDO cards do not use a SIM.

1. Follow the procedures in [Before You Begin](#).
2. In the battery bay, slide the SIM into the compartment.

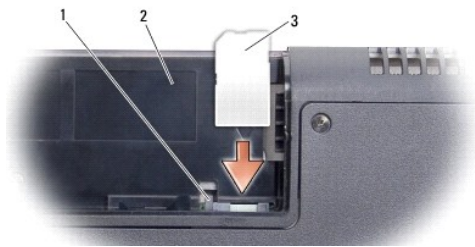

1	SIM eject bar	2	battery bay
3	SIM		

### Removing the SIM

1. Press the SIM eject bar to release the SIM.
2. When it is partially ejected, remove the SIM from the battery bay.

---

## Wireless Mini-Cards

**CAUTION:** Before working inside your computer, read the safety information that shipped with your computer. For additional safety best practices information, see the [Regulatory Compliance Homepage](http://www.dell.com/regulatory_compliance) at [www.dell.com/regulatory\\_compliance](http://www.dell.com/regulatory_compliance).

**NOTICE:** To help prevent damage to the system board, you must remove the battery from the battery bay before you begin working inside the computer.

**NOTICE:** Only a certified service technician should perform repairs on your computer. Damage due to servicing that is not authorized by Dell™ is not covered by your warranty.

**NOTE:** Dell does not guarantee compatibility or provide support for Mini-Cards from sources other than Dell.

If you ordered a wireless Mini-Card with your computer, the card is already installed.

Your computer supports three Mini-Card slots:

- 1 two Full Mini-Card slots – for WWAN, WPAN, UWB, Bluetooth

- 1 one Half Mini-Card slot – for WLAN

The types of Mini-Cards supported are:

- 1 Wireless Local Area Network (WLAN) — Half Mini-Card
- 1 Ultra Wide Band (UWB) — Full Mini-Card
- 1 Mobile broadband or Wireless Wide Area Network (WWAN) — Full Mini-Card
- 1 Wireless Personal Area Network (WPAN) or Internal Card with Bluetooth® Wireless Technology — Full Mini-Card

 **NOTE:** Your computer can only support two Full Mini-Cards and one Half Mini-Card at a time.

 **NOTE:** The WLAN slot supports a half Mini-Card.

 **NOTE:** Depending on the configuration of the system when it was sold, one or more of the Mini-Card slots may not have Mini-Cards installed in them.

## Removing the Mini-Card

1. Follow the instructions in [Before You Begin](#).
2. Turn the computer over and remove the base cover (see [Removing the Base Cover](#)).

 **NOTICE:** When you disconnect a cable, pull on its connector or on its pull-tab, not on the cable itself. Some cables have connectors with locking tabs; if you are disconnecting this type of cable, press in on the locking tabs before you disconnect the cable. As you pull connectors apart, keep them evenly aligned to avoid bending any connector pins. Also, before you connect a cable, ensure that both connectors are correctly oriented and aligned.

3. Disconnect the antenna cables from the Mini-Card.

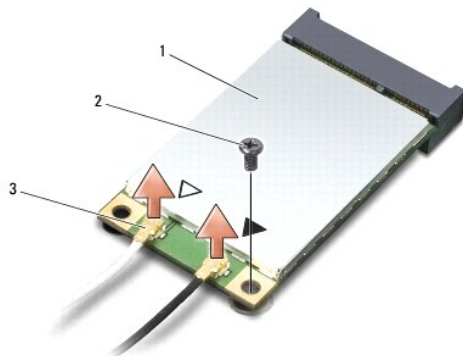

1	Mini-Card	2	securing screw	3	antenna cable connectors (2)
---	-----------	---	----------------	---	------------------------------

 **NOTE:** If you are removing a WPAN/UWB Mini-Card, disconnect the blue antenna cable from the Mini-Card.

4. Remove the securing screw that connects the Mini-Card to the system board.
5. Lift the Mini-Card out of the system board connector.

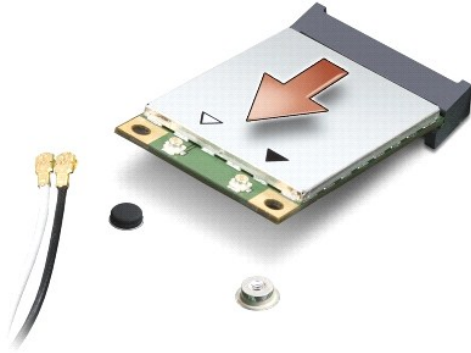

➔ **NOTICE:** When the Mini-Card is not in the computer, store it in protective antistatic packaging. For more information, see "Protecting Against Electrostatic Discharge" in the safety information that shipped with your computer.

## Replacing the Mini-Card

➔ **NOTICE:** Install the UWB Mini-Card in the WWAN or WPAN slot. Do not install a UWB Mini-Card in the WLAN card slot. Doing so may cause damage to your computer.

1. Remove the new Mini-Card from its packaging.

➔ **NOTICE:** Use firm and even pressure to slide the card into place. If you use excessive force, you may damage the connector.

2. Insert the Mini-Card connector at a 45-degree angle into the appropriate system board connector. For example, the WLAN card connector is labeled **WLAN** and so on.
3. Press the other end of the Mini-Card down into the slot on the system board.
4. Replace the securing screw.
5. Connect the appropriate antenna cables to the Mini-Card you are installing. The following table provides the antenna cable color scheme for each Mini-Card supported by your computer.

Connectors on the Mini-Card	Antenna Cable Color Scheme
<b>WWAN (2 antenna cables)</b>	
Main WWAN (white triangle)	white with gray stripe
Auxiliary WWAN (black triangle)	black with gray stripe
<b>WLAN (2 or 3 antenna cables)</b>	
Main WLAN (white triangle)	white
Auxiliary WLAN (black triangle)	black
MIMO WLAN (*gray triangle)	gray
<b>WPAN (one antenna cable)</b>	
WPAN	blue

\* The MIMO WLAN is optional and may not be available in all computers.

🔍 **NOTE:** The gray antenna cable may not be available in all computers. The presence of the gray antenna cable in your Mini-Card compartment depends upon the type of display.

6. Secure the unused antenna cables in the protective mylar sleeve.
7. Replace the base cover (see [Replacing the Base Cover](#)).
8. Slide the battery into the bay until it clicks into place.
9. Install the drivers and utilities for your computer, as required. For more information, see the *Dell Technology Guide*.

 **NOTE:** If you are installing a communication card from a source other than Dell, you must install the appropriate drivers and utilities. For more generic driver information, see the *Dell Technology Guide*.

---

[Back to Contents Page](#)

## Optical Drive

### Dell™ Studio 1735/1737 Service Manual

- [Removing the Optical Drive](#)
- [Replacing the Optical Drive](#)

**CAUTION:** Before working inside your computer, read the safety information that shipped with your computer. For additional safety best practices information, see the Regulatory Compliance Homepage at [www.dell.com/regulatory\\_compliance](http://www.dell.com/regulatory_compliance).

**NOTICE:** To avoid electrostatic discharge, ground yourself by using a wrist grounding strap or by periodically touching an unpainted metal surface (such as the back panel) on the computer.

## Removing the Optical Drive

1. Follow the instructions in [Before You Begin](#).
2. Follow the instructions in [Removing the Palm Rest](#).
3. Turn the computer upside down and remove the screw that secures the optical drive to the computer base.

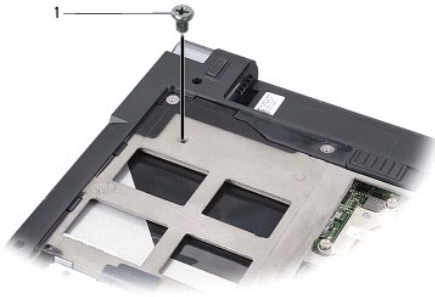

1	screw (1)		
---	-----------	--	--

4. Turn the computer over and remove the three screws that secure the optical drive to the computer base.

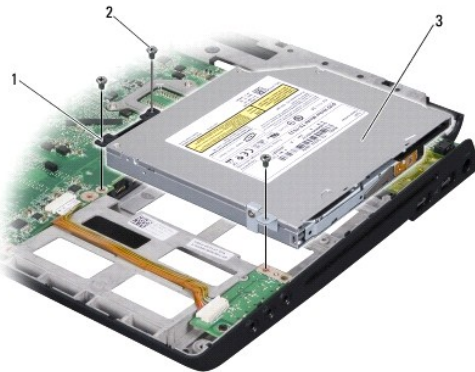

1	interposer	2	screw (3)
3	optical drive		

5. Lift the drive out of the computer base.
6. Remove the optical drive interposer from the drive.

---

## Replacing the Optical Drive

1. Connect the optical drive interposer to the drive.
2. Place the drive back in position and replace the three screws that secure the optical drive to the computer base.
3. Turn the computer upside down and replace the screw that secures the optical drive to the computer base.
4. Turn the computer top side up and follow the instructions in [Replacing the Palm Rest](#).

---

[Back to Contents Page](#)



## Palm Rest

### Dell™ Studio 1735/1737 Service Manual

- [Removing the Palm Rest](#)
- [Replacing the Palm Rest](#)

**⚠ CAUTION:** Before working inside your computer, read the safety information that shipped with your computer. For additional safety best practices information, see the Regulatory Compliance Homepage at [www.dell.com/regulatory\\_compliance](http://www.dell.com/regulatory_compliance).

**👉 NOTICE:** To avoid electrostatic discharge, ground yourself by using a wrist grounding strap or by periodically touching an unpainted metal surface (such as the back panel) on the computer.

## Removing the Palm Rest

1. Follow the instructions in [Before You Begin](#).
2. Press and eject any installed cards from the ExpressCard slot and the 8-in-1 memory card reader.
3. Remove any installed memory modules and Mini-Cards (see [Memory](#) and [Communication Cards](#)).
4. Follow the instructions in [Display Assembly](#).
5. Turn the computer upside down and remove the eight screws from the computer base.



6. Turn the computer top side up and remove the four screws from the top of the palm rest.

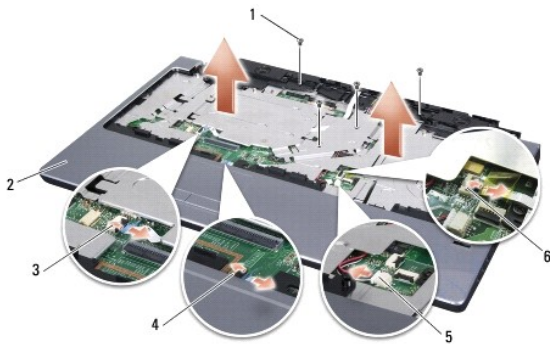

1 screw (4)	2 palm rest
3 media control buttons cable connector	4 touch pad cable connector
5 speaker cable connector	6 fingerprint cable connector (optional)

**👉 NOTICE:** Pull on the plastic tab on top of the connectors to avoid damaging the connectors.

7. Disconnect the speaker cable connector, touch pad cable connector, media control buttons cable connector, and the optional fingerprint reader cable connector from the system board.
8. Starting at the back center of the palm rest, use your fingers to gently ease the palm rest from the computer base by lifting the inside of the palm rest while pulling on the outside.

 **NOTICE:** Carefully separate the palm rest from the computer base to avoid damage to the palm rest.

---

## Replacing the Palm Rest

1. Align the palm rest with the computer base and gently snap the palm rest into place.
  2. Connect the speaker cable, touch pad cable, media control buttons cable, and the optional fingerprint reader cable to the respective system board connectors.
  3. Replace the four screws on the top of the palm rest.
  4. Turn the computer upside down and replace the eight screws in the computer base.
  5. Follow the instructions in [Replacing the Display Assembly](#).
  6. Reinstall the memory modules and Mini-Cards, if any.
  7. Reinstall any removed cards in the ExpressCard and 8-in-1 card slots.
- 

[Back to Contents Page](#)

## Speakers

### Dell™ Studio 1735/1737 Service Manual

- [Removing the Speakers](#)
- [Replacing the Speakers](#)

**⚠ CAUTION:** Before working inside your computer, read the safety information that shipped with your computer. For additional safety best practices information, see the Regulatory Compliance Homepage at [www.dell.com/regulatory\\_compliance](http://www.dell.com/regulatory_compliance).

**🔌 NOTICE:** To avoid electrostatic discharge, ground yourself by using a wrist grounding strap or by periodically touching an unpainted metal surface (such as the back panel) on the computer.

---

## Removing the Speakers

1. Follow the instructions in [Before You Begin](#).
2. Press and eject any installed cards from the ExpressCard slot and the 8-in-1 memory card reader.
3. Remove any installed memory modules and Mini-Cards (see [Memory](#) and [Communication Cards](#)).
4. Follow the instructions in [Display Assembly](#).
5. Remove the four speaker screws (two on each speaker) from the computer base.

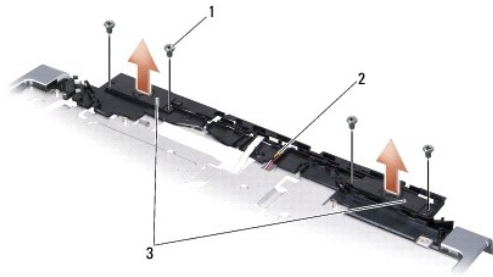

1	screw (4)	2	speaker cable	3	speaker (2)
---	-----------	---	---------------	---	-------------

6. Remove the palm rest (see [Removing the Palm Rest](#)).
  7. Make note of the speaker cable routing.
  8. Remove the speakers and the cable.
- 

## Replacing the Speakers

1. Replace the speakers and the speaker cable.
  2. Connect the speaker cable to the connector on the system board.
  3. Replace the four speaker screws (two on each speaker) that secure the speakers to the palm rest.
  4. Replace the palm rest (see [Replacing the Palm Rest](#)).
  5. Follow the instructions in [Replacing the Display Assembly](#).
  6. Reinstall the memory modules and Mini-Cards, if any.
  7. Reinstall any removed cards in the ExpressCard and 8-in-1 card slots.
-

[Back to Contents Page](#)

## System Board

### Dell™ Studio 1735/1737 Service Manual

- [Removing the System Board](#)
- [Replacing the System Board](#)

**⚠ CAUTION:** Before working inside your computer, read the safety information that shipped with your computer. For additional safety best practices information, see the Regulatory Compliance Homepage at [www.dell.com/regulatory\\_compliance](http://www.dell.com/regulatory_compliance).

**➡ NOTICE:** To avoid electrostatic discharge, ground yourself by using a wrist grounding strap or by periodically touching an unpainted metal surface (such as the back panel) on the computer.

The system board's BIOS chip contains the Service Tag, which is also visible on a barcode label on the bottom of the computer. The replacement kit for the system board includes a CD that provides a utility for transferring the Service Tag to the replacement system board.

**➡ NOTICE:** Handle components and cards by their edges, and avoid touching pins and contacts.

---

## Removing the System Board

1. Follow the instructions in [Before You Begin](#).
2. Press and eject any installed cards from the ExpressCard slot and the 8-in-1 memory card reader.
3. Remove any installed memory modules and Mini-Cards (see [Memory](#) and [Communication Cards](#)).
4. Remove the hard drive (see [Removing the Hard Drive](#)).
5. Remove the processor heat sink and processor (see [Removing the Processor Heat Sink](#) and [Removing the Processor](#)).
6. Remove the center control cover (see [Removing the Center Control Cover](#)).
7. Remove the keyboard (see [Removing the Keyboard](#)).
8. Remove the display assembly (see [Removing the Display Assembly](#)).
9. Remove the palm rest (see [Removing the Palm Rest](#)).

**🔧 NOTE:** According to the configuration you have received, you may have to loosen two more captive screws from the back of the computer to remove the system board.

10. Remove the optical drive (see [Removing the Optical Drive](#)).
11. Loosen the two captive screws on the graphic chip.



1	captive screw (2)		
---	-------------------	--	--

12. Remove the five screws (marked B) that secure the system board to the computer base. The order of removing the screws is indicated by the numbers

that are located next to the screws on the system board.

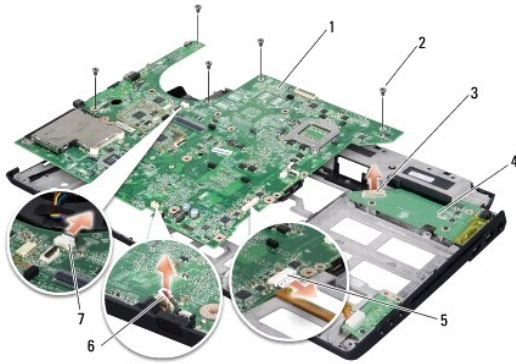

1	system board	2	screw (5)
3	charger board connector	4	charger board
5	audio cable connector	6	microphone cable connector
7	fan cable connector		

13. Disconnect the microphone cable connector, fan cable connector, and audio cable connector.
14. Pull the system board to detach it from the connector on the charger board.
15. Lift the system board at an angle toward the side of the computer and out of the computer base.

---

## Replacing the System Board

1. Replace the system board in the computer base.
2. Connect the system board to the connector on the charger board.
3. Connect the microphone cable connector, fan cable connector, and audio cable connector.
4. Replace the five screws (in the reverse order of removal) that secure the system board to the computer base.
5. Replace the optical drive (see [Replacing the Optical Drive](#)).
6. Replace the palm rest (see [Replacing the Palm Rest](#)).
7. Replace the display assembly (see [Replacing the Display Assembly](#)).
8. Replace the keyboard (see [Replacing the Keyboard](#)).
9. Replace the center control cover (see [Replacing the Center Control Cover](#)).
10. Replace the processor heat sink and processor (see [Replacing the Processor Heat Sink](#) and [Installing the Processor](#)).
11. Replace the hard drive (see [Replacing the Hard Drive](#)).
12. Reinstall the memory modules and Mini-Cards, if any.
13. Reinstall any removed cards in the ExpressCard and 8-in-1 card slots.

**NOTICE:** Before turning on the computer, replace all screws and ensure that no stray screws remain inside the computer. Failure to do so may result in damage to the computer.

14. Turn on the computer.

**NOTE:** After you have replaced the system board, enter the computer Service Tag into the BIOS of the replacement system board.

15. Insert the BIOS CD that accompanied the replacement system board into the appropriate drive. Follow the instructions that appear on the screen.

---

[Back to Contents Page](#)